

veito

CARBON INFRARED HEATER

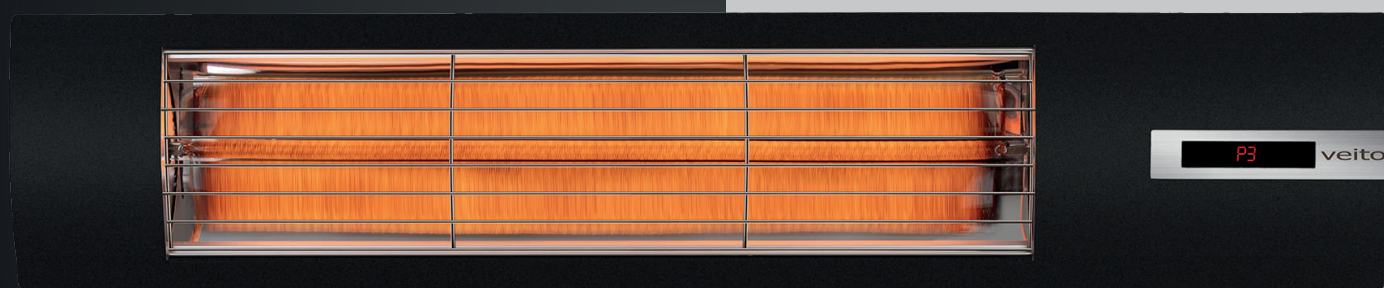

SPACE

veito

veito

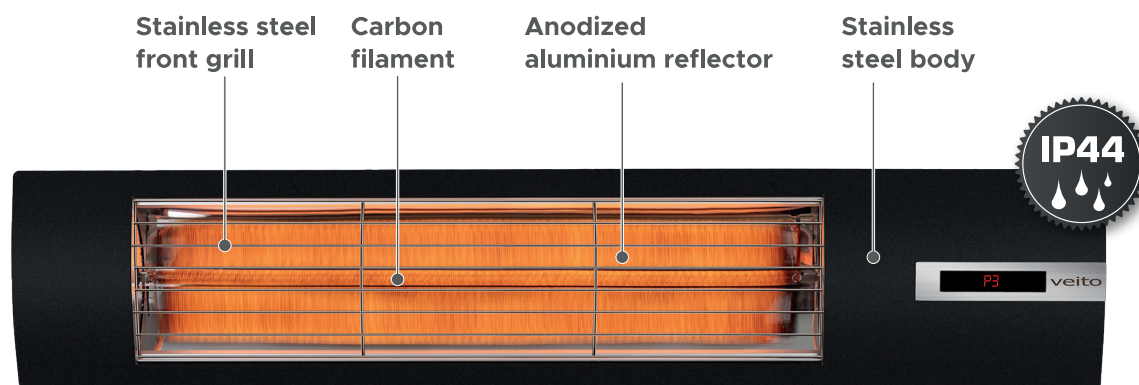

ZERO noise
odor
greenhouse gases

SPACE S

Height	170mm
Width	850 mm
Depth	70 mm
Voltage	240V AC
Frequency	50/60Hz
Maximum power	2500W
Power settings	Low-Mid-High
IP rating	IP44

SPACE

Height	170mm
Width	800mm
Depth	70 mm
Voltage	120V AC
Frequency	50/60Hz
Maximum power	1500W
Power settings	Low-Mid-High
IP rating	IP44

CARBON INFRARED HEATER

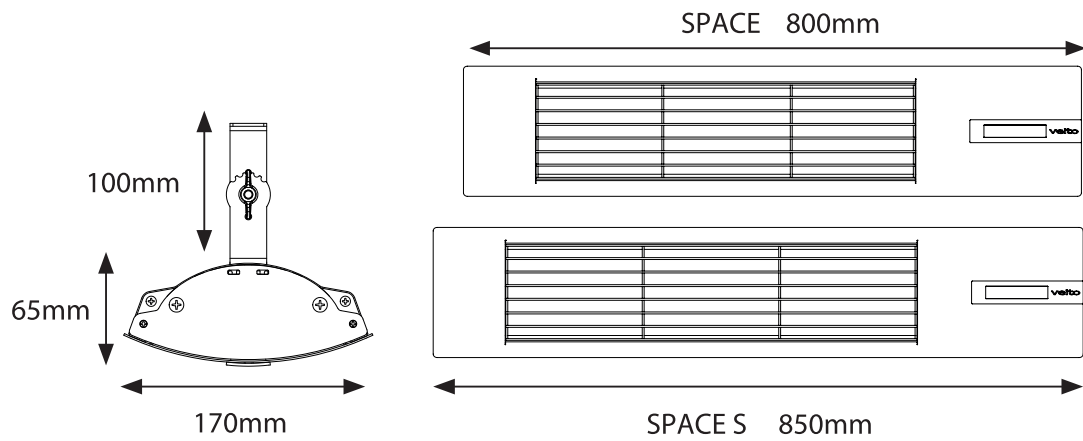

DIGITAL THERMOSTAT



FROM REMOTE CONTROL





THE SPACE

Carbon infrared heater generates low-glare, medium-wave infrared heat. Its comfortable warmth is quickly distributed over a wide area, thanks to a specially designed reflector. The wavelength of the emitted light enables the heat to travel long distances, transforming into a pleasant warmth. The heating intensity can be easily adjusted using the remote control. This innovative heater operates with exceptional energy efficiency, eliminating the need for additional insulation. As a result, it not only reduces energy costs but also provides a consistent and comfortable environment year-round.

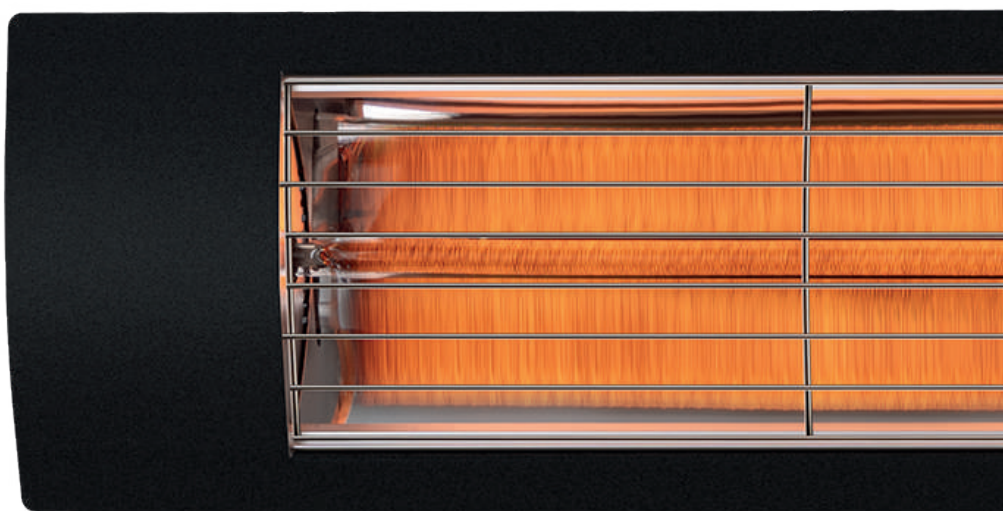

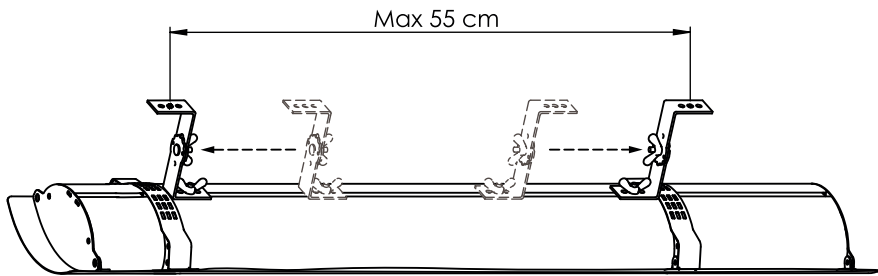
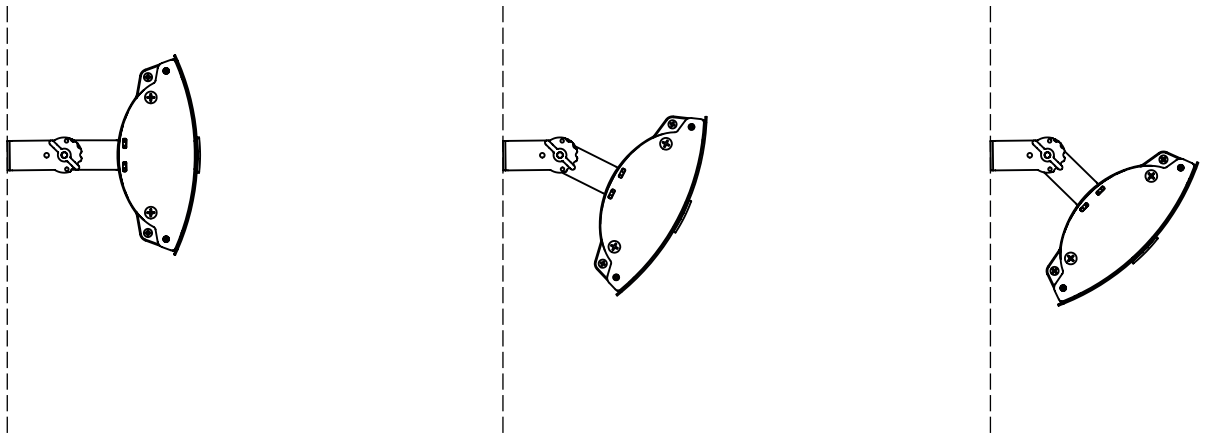

OUTDOOR COVERAGE AREA



AVERAGE 10M²

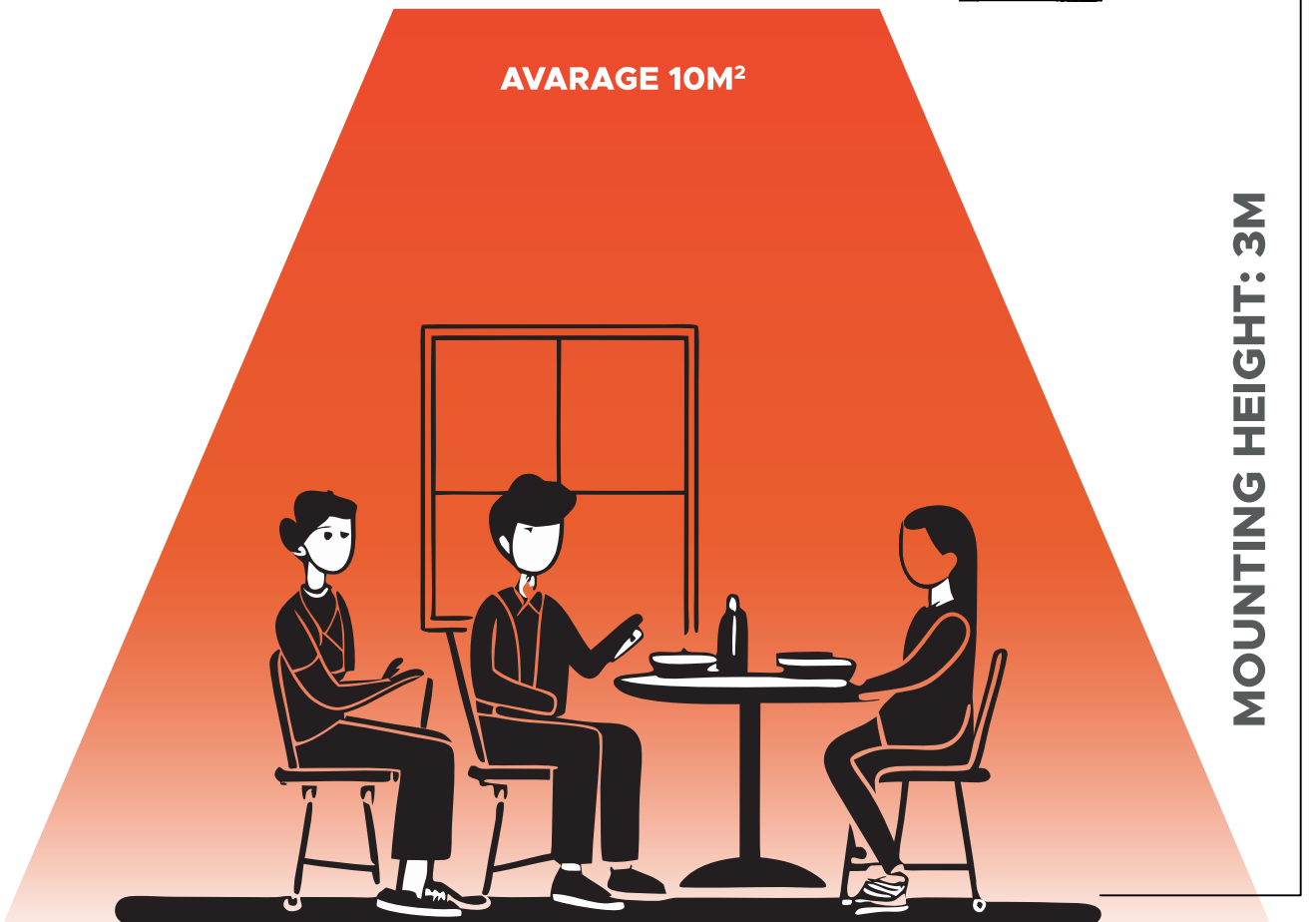

MOUNTING HEIGHT: 3M

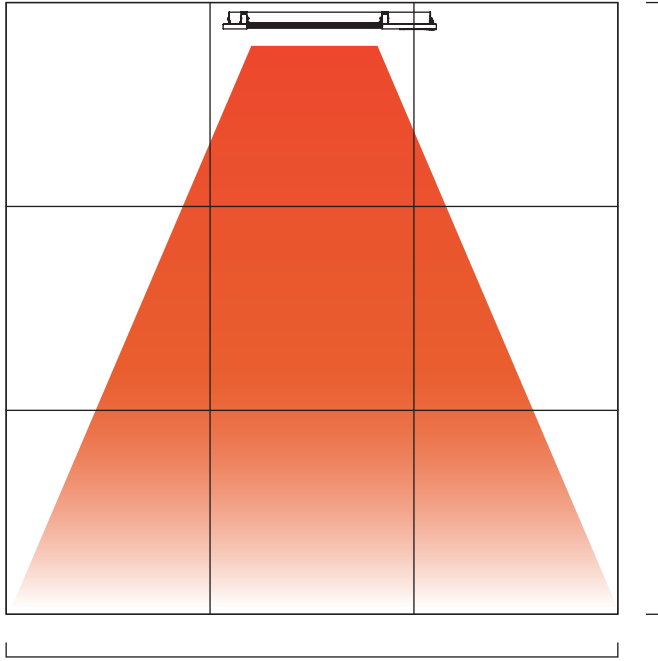
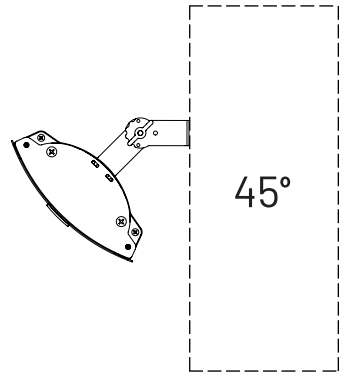
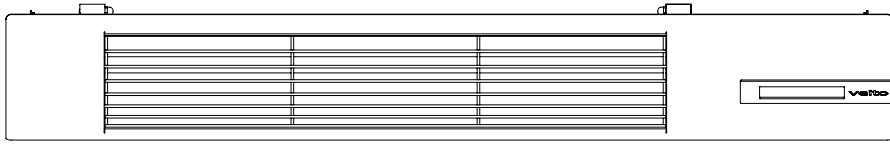

3 m

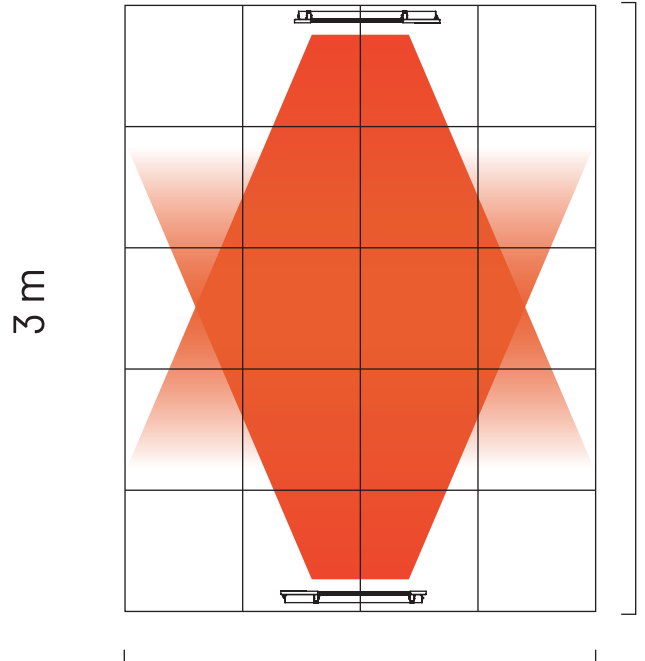

3 m

5 m

4 m

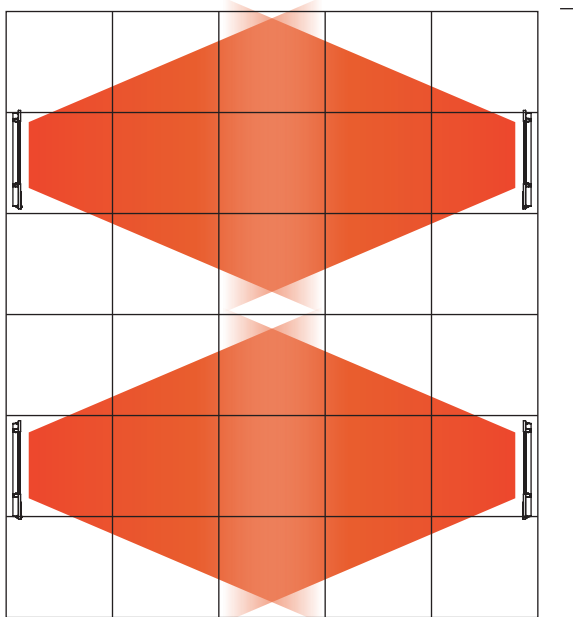

6 m

5 m

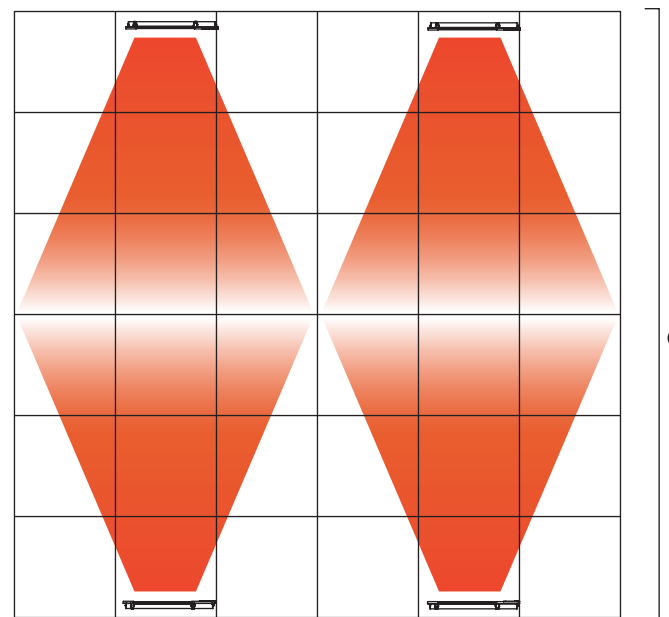

6 m

6 m

veito



SPACE

CARBON INFRARED HEATER